

Service
Service
Service



Training Manual



Table of Contents

Warning - ESD.....2
 Wiring.....3
 Brief description4
 Truth table6
 Timing Diagram7
Repair Tips
 Replacing the CD Drive.....11
 Jammed carriage, blocked tray12
 Replacing the gears15
 Exploded view.....20

© Copyright 2001 Philips Consumer Electronics B.V. Eindhoven, The Netherlands
 All rights reserved. No part of this publication may be reproduced, stored in a retrieval system or transmitted, in any form or by any means, electronic, mechanical, photocopying, or otherwise without the prior permission of Philips.

Published by HB 0148 Service Audio Printed in The Netherlands Subject to modification



GB 3103 785 25140



PHILIPS

WARNING

CHARGED CAPACITORS ON THE SERVO BOARD MAY DAMAGE THE CD DRIVE ELECTRONICS WHEN CONNECTING A NEW CDM MECHANISM. THAT'S WHY, BESIDES THE SAFETY MEASURES LIKE

- **SWITCH OFF POWER SUPPLY**
- **ESD PROTECTION**

ADDITIONAL ACTIONS MUST BE TAKEN BY THE REPAIR TECHNICIAN.

The following steps have to be done when replacing the CD mechanism:

1. Disconnect flexfoil from old CD drive
2. Put a paperclip over contacts of flexfoil to short-circuit the contacts (fig.1)
3. Remove old CD drive
4. Remove paperclip from flexfoil
5. Connect flexfoil to new CD drive
6. Remove ESD-protection (solder joint) from laserunit (see below)
7. Position new CD drive in its studs

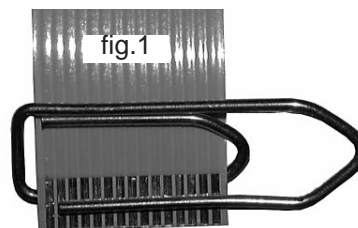

Attention: The laser diode of this CD drive is protected against ESD by a solder joint which shortcircuits the laserdiode to ground.
For proper functionality of the CD drive this solder joint must be removed **after** connection the drive to the set.

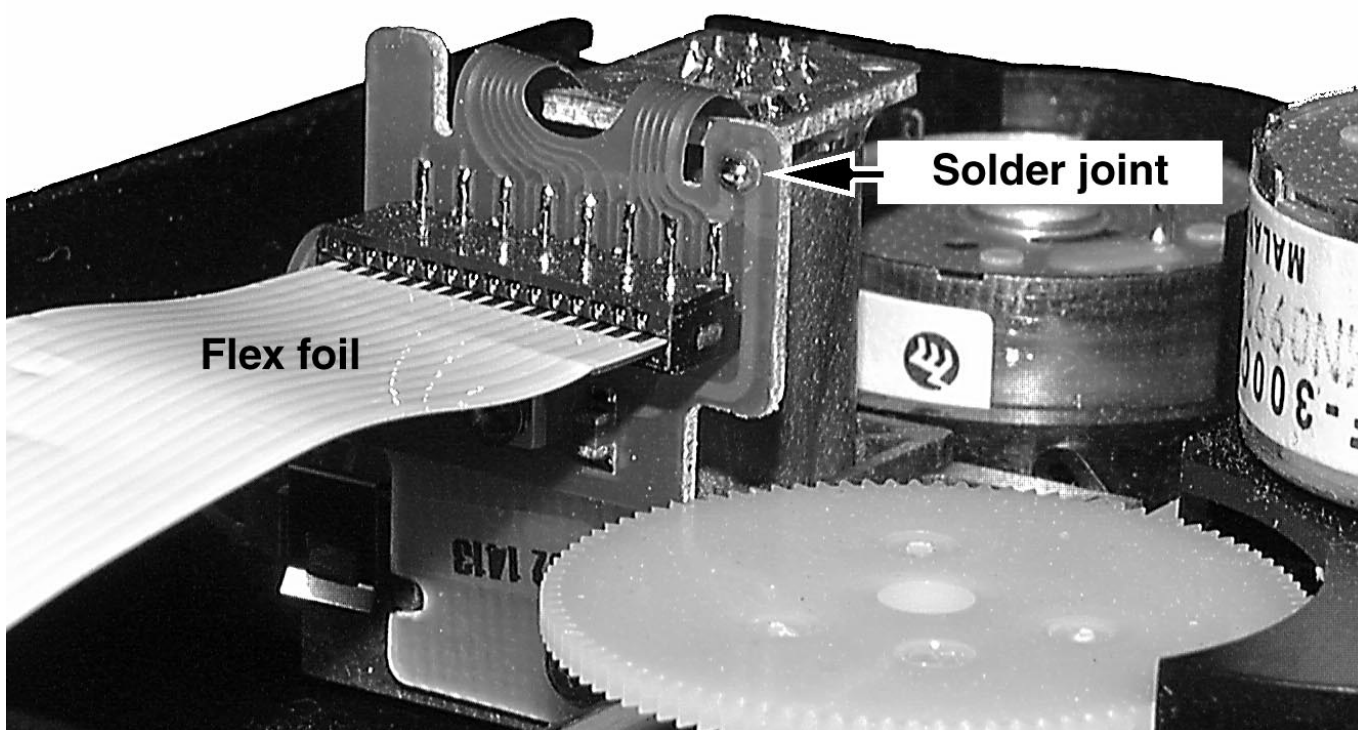

WIRING Module

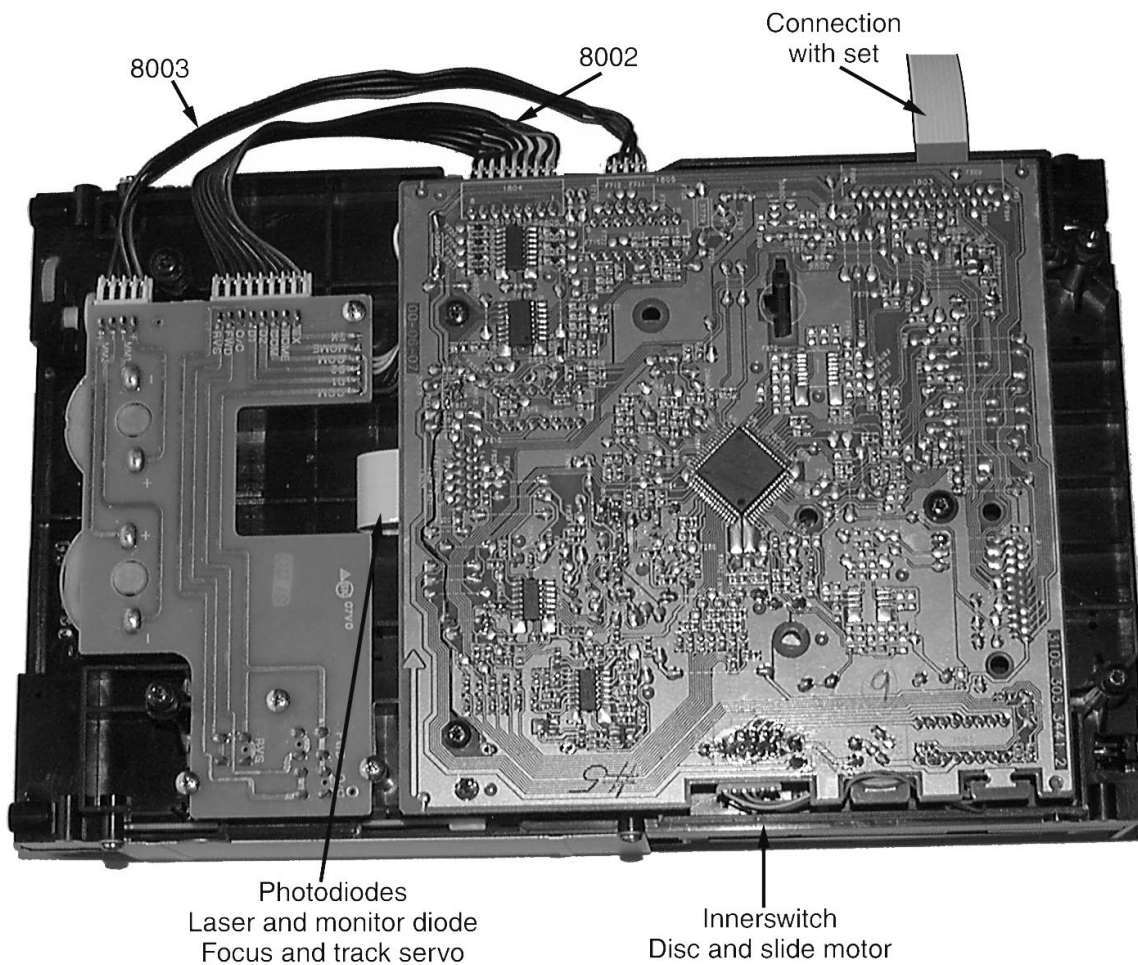

WIRING CD Drive

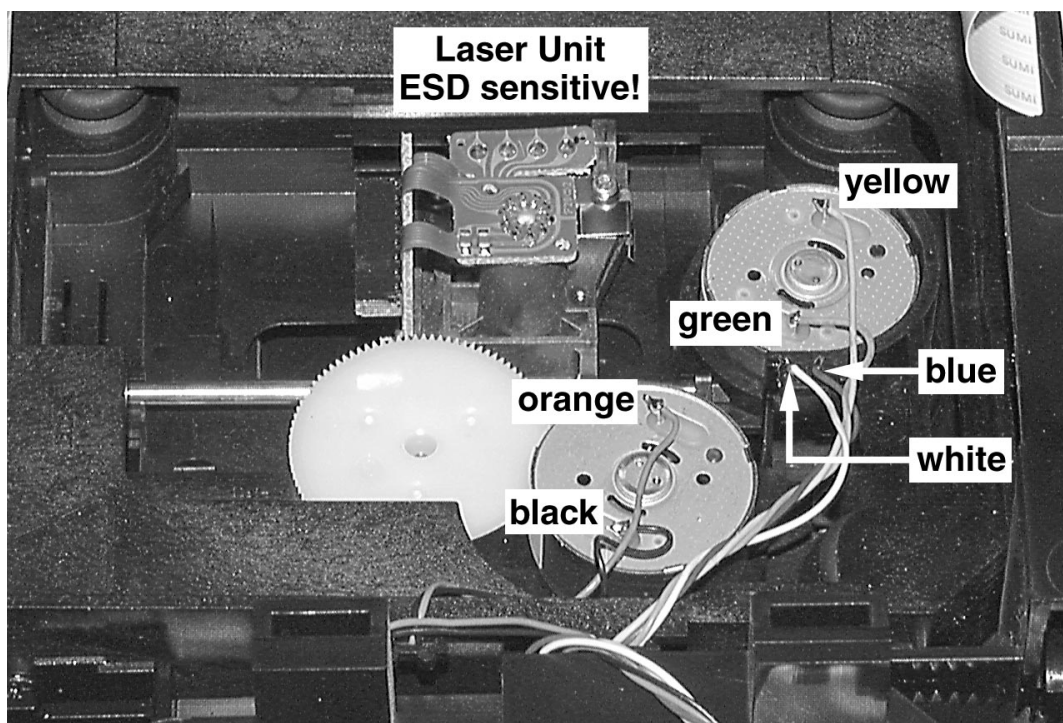

Brief description

On the next pages various actions of the 3 Disc Tray Changer are described with simplified drawings.

1. Initial state. After Power on the changer is in this position.

The drawer closed

Carriage #1 is in Play position

Carriage #2 and #3 are in home position

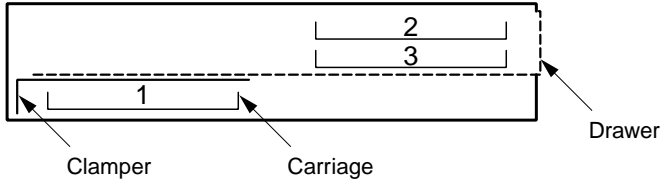

The Changer looks like



2. Tray open.

The Drawer is moved out

Carriage #2 and #3 remain in home position

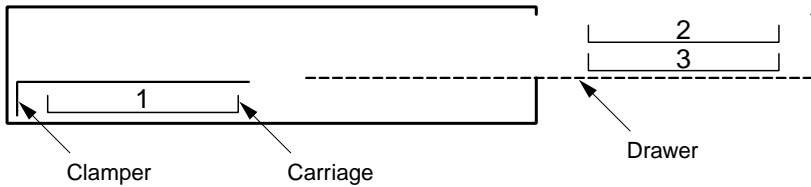

The Changer looks like

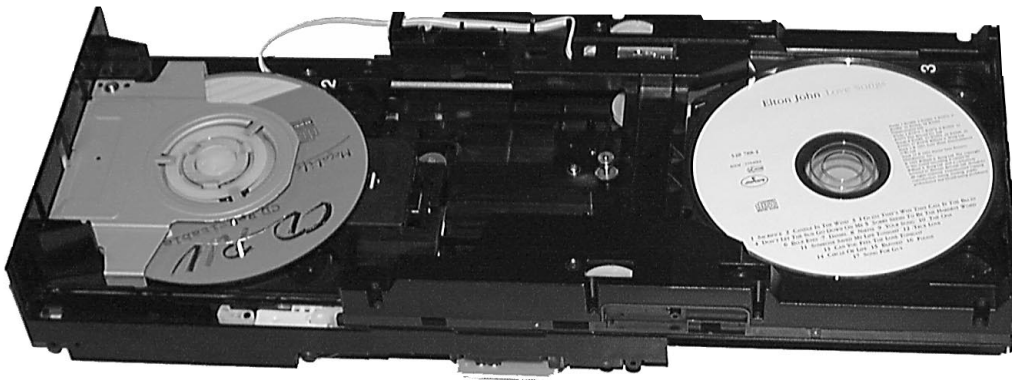

3. Carriage extra.

This position is necessary to get access to the lower carriage. It is also used during disc change.

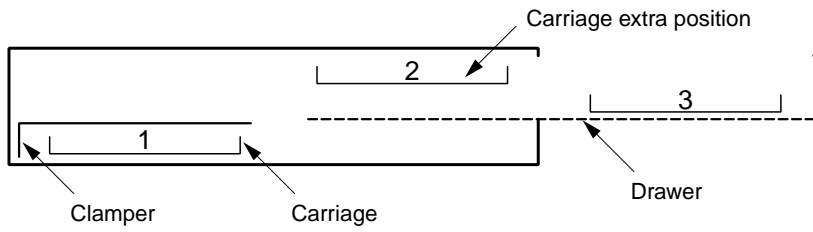

The changer looks like

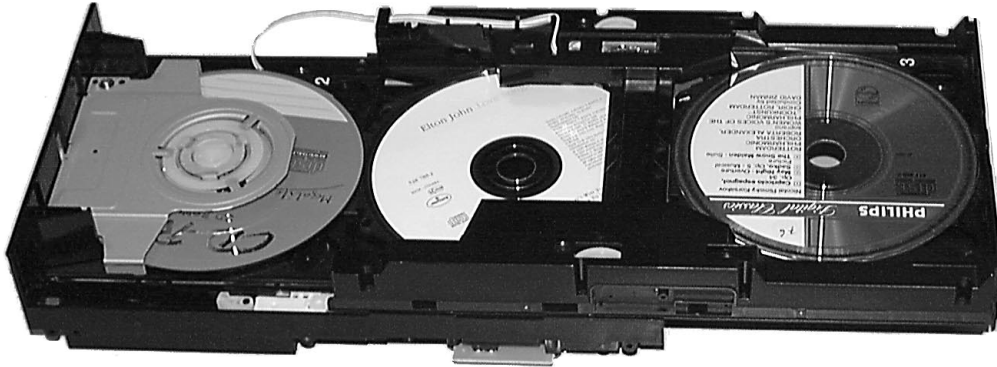

The various states are recognized by seven switches.
For functions see truth table on next page.

Location of switches

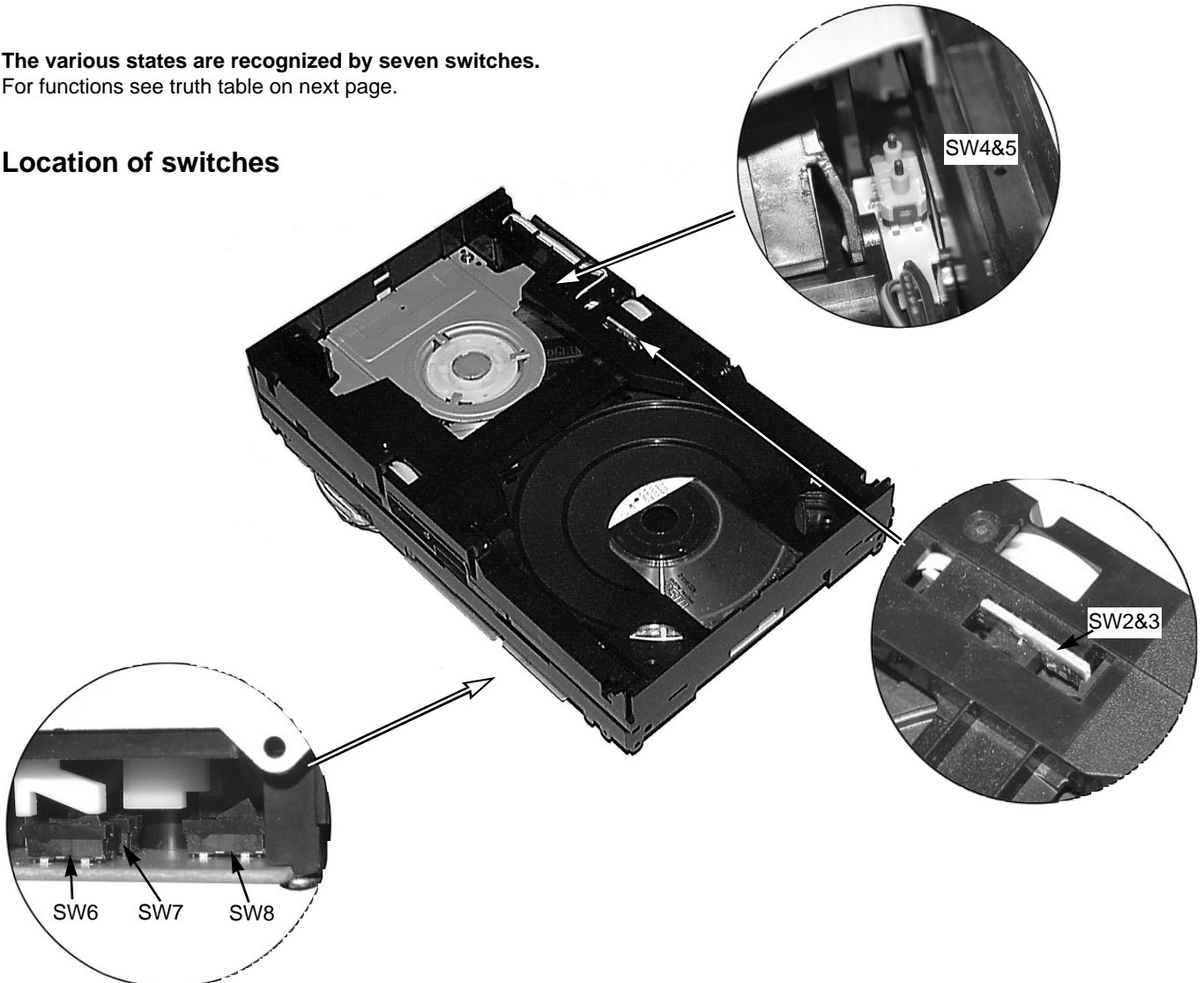

Timing Diagrams

1. Open #3

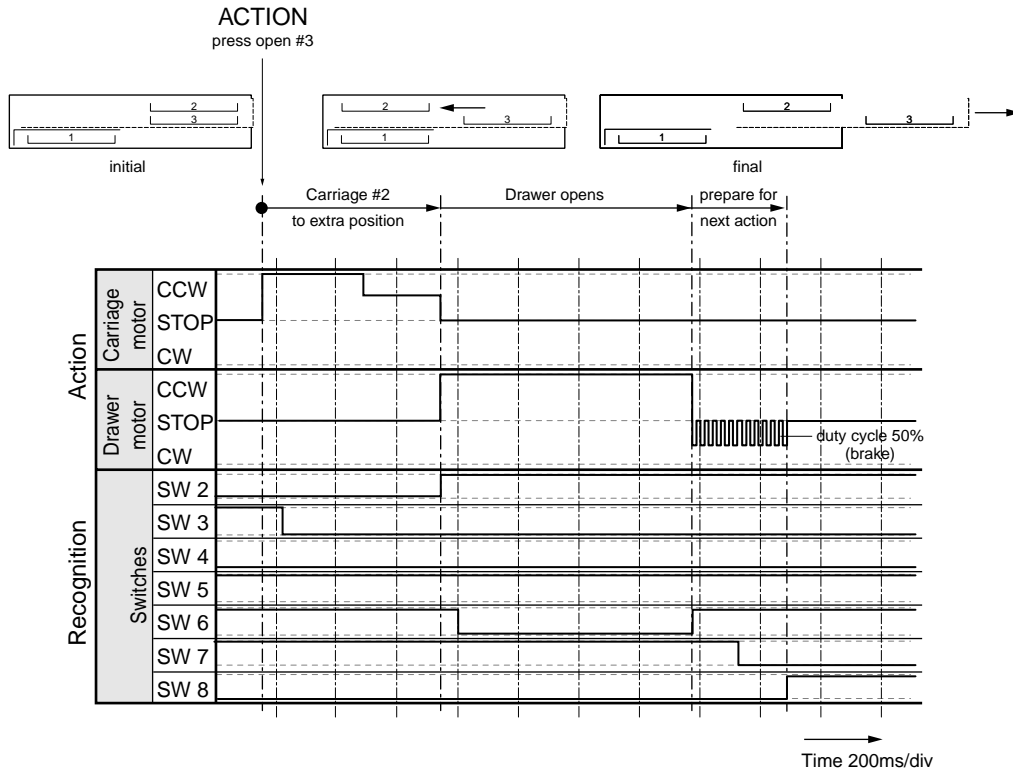

2. Close #3

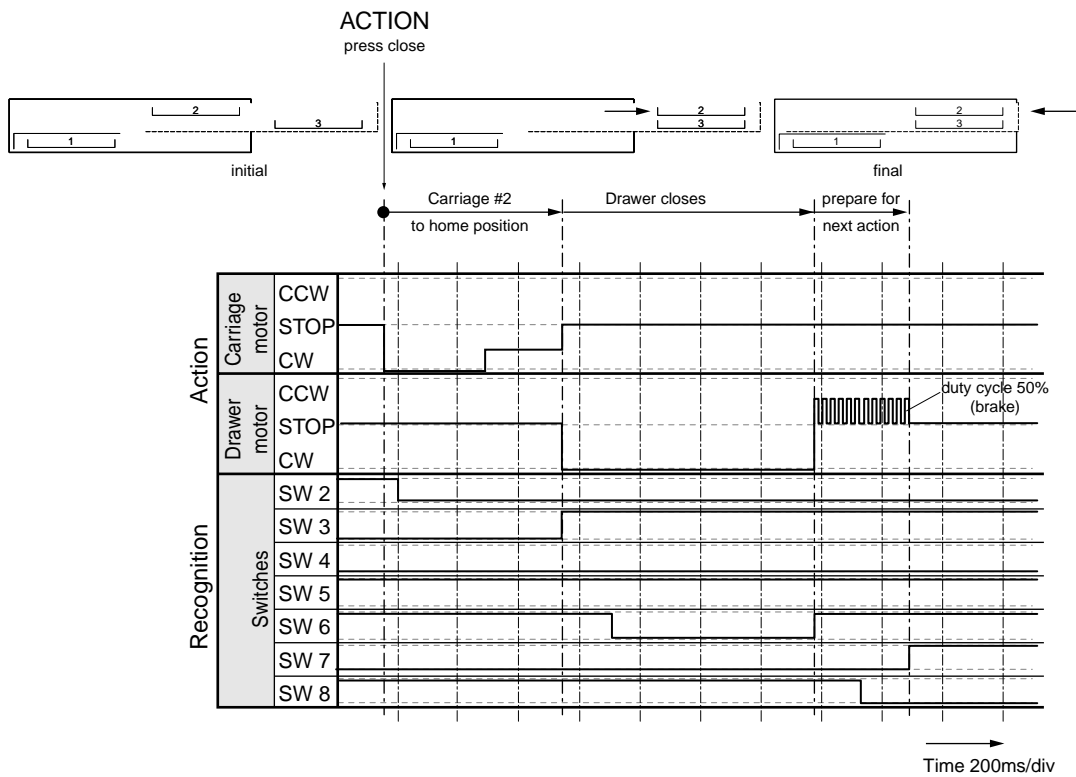

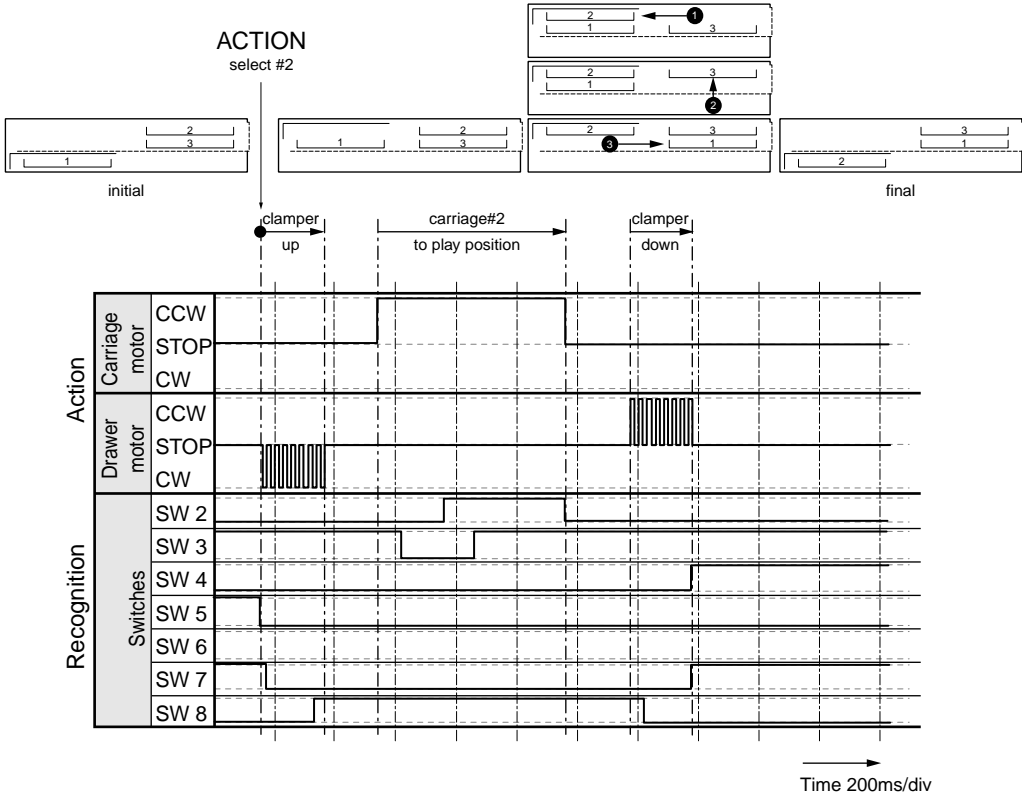

3. Select #2

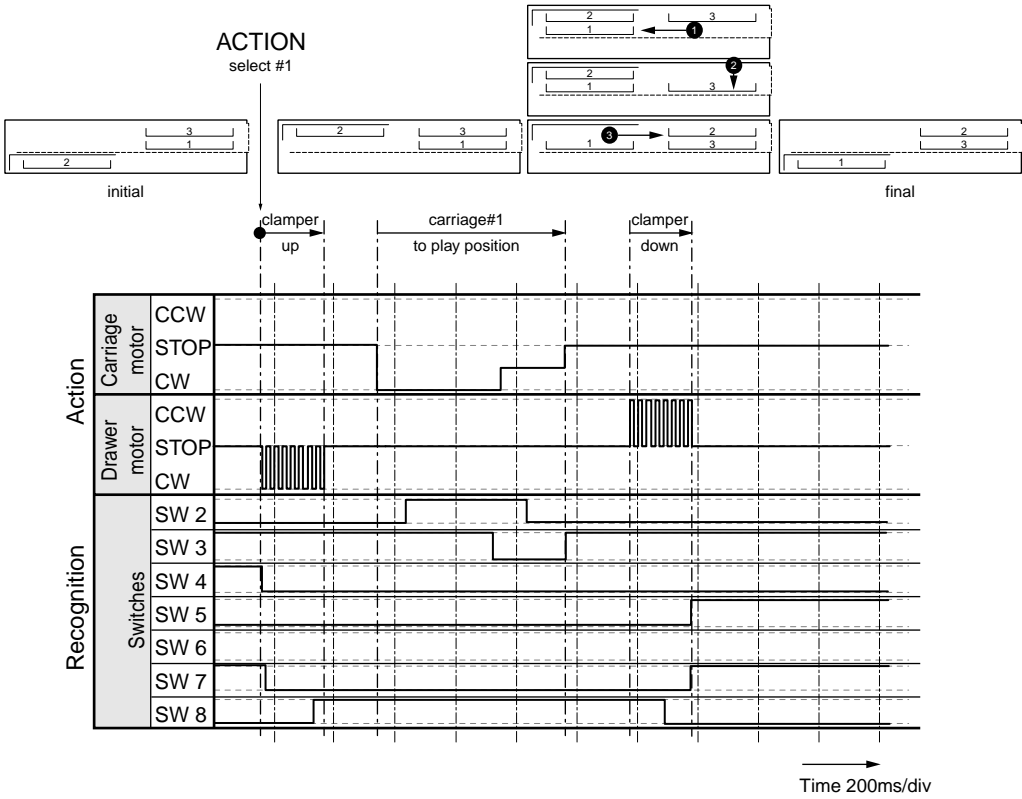

4. Select #1

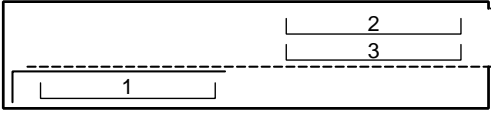
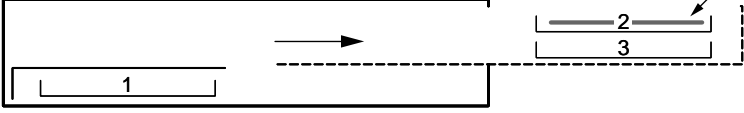
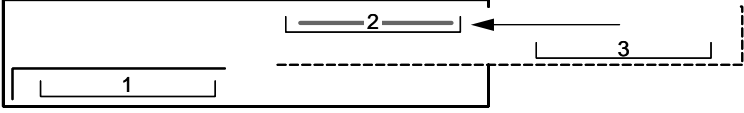

Load all discs

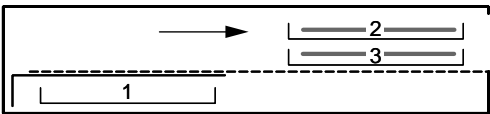
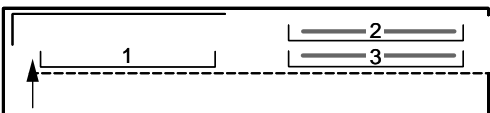
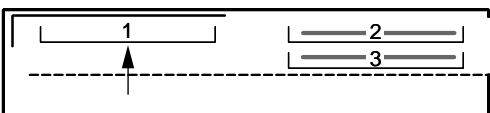
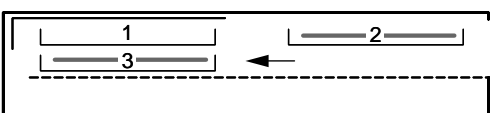
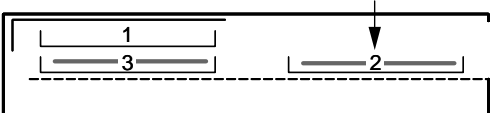
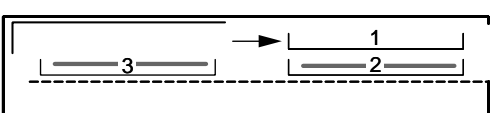
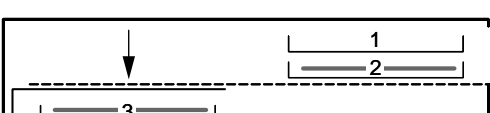
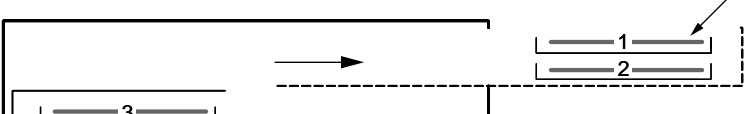
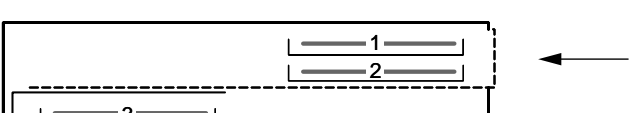
1. Power on. Initial state.
 
2. Press open #2.
Tray moves out.
Load carriage #2.
 
3. Press open #3.
Carriage #2 moves in extra position.
 
4. Load carriage #3.
 
5. Press open #1.
Tray closes.
 
6. Carriage #2 moves in home position.
 
7. Clamper moves to upper position.
Carriage #1 moves to height of carriage #3.
 
8. Carriage #1 moves to height of carriage #2.
 
9. Carriage #3 moves below carriage #1.
 
10. Carriage #2 moves down.
 
11. Carriage #1 moves in home position.
 
12. Carriage #3 and clamper move down (in play position).
 
13. Tray moves out.
Load carriage #1.
 
14. Press close.
Tray closes.
 

Change 'backwards'

E.g. select #3 while playing #1.

Change 'forwards'

E.g. select #2 while playing #1.

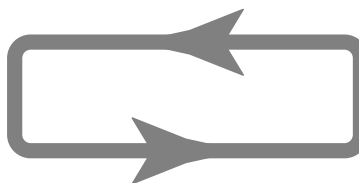
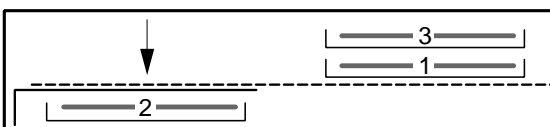
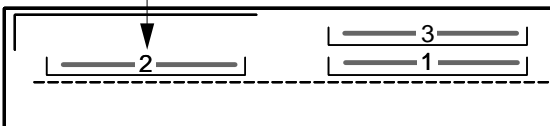
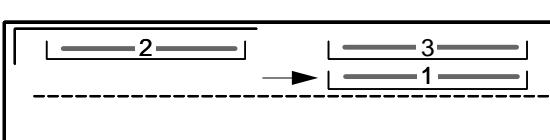
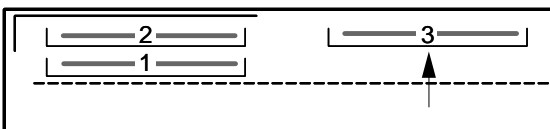
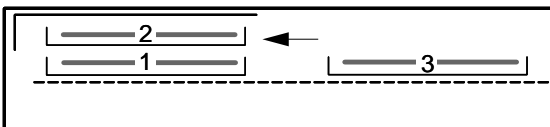
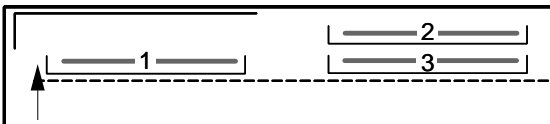
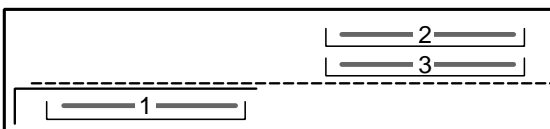
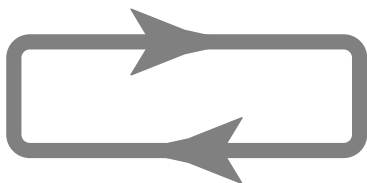
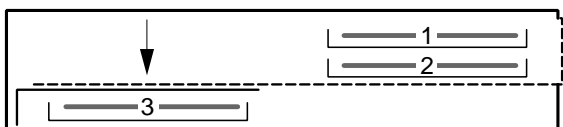
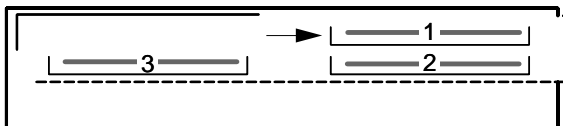
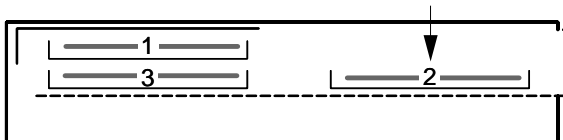
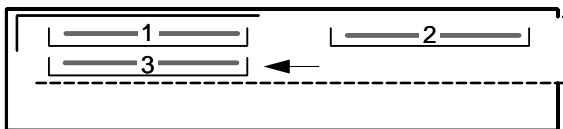
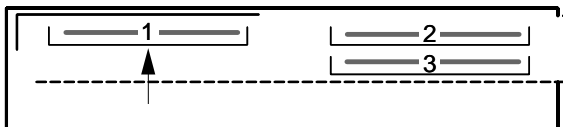
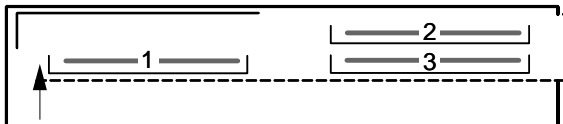
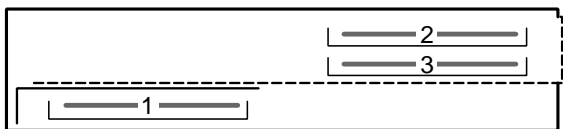

See also timing diagrams (page 8).

Additional hints:

Gears pos. ④ and pos. ⑤ are responsible for forward/backward movement of the carriages.

Star Gears pos. ⑱ are responsible for up/down movement of the carriages.

Mis-aligned gears (pos. ④ & ⑤) result in jamming carriages.

Wrong inserted carriages (e.g. #2 mixed up with #3) causes endless forward/backward changing of the loader module.

Repair Tips

Replacing the CD Drive

1. Dismantle top and side cover of set.
2. Loosen 4x screw (see picture 1).
Remove metal cover of changer.
3. Connect mains and switch on the set.
4. Press Open/Close CD button → Tray moves outside.
5. Disconnect mains.
6. Loosen 2x screw (see picture 2).
Remove bracket with clumper.
7. Remove carriage above CD-drive.
8. Loosen 4x screw (see picture 3).
Remove CD-drive.
9. Disconnect flex foil and short-circuit it
(see page 2).
10. Desolder wires.
11. Remove dampers pos. 57 and 58.
12. Insert dampers into new CD-drive.
13. Solder wires to new CD-drive (see page 3).
14. Connect flexfoil.
15. Remove solder joint on new CD-drive
(see page 3).
16. Position the new CD drive in its studs.
17. Fix the drive - 4x screw (see picture 3).
18. Insert carriage.
19. Mount bracket with clumper - 2x screw (see picture 2).
20. Mount metal cover of the loader unit - 4x screw
(see picture 1).
21. Connect mains → Press Open/Close CD button →
Tray closed.

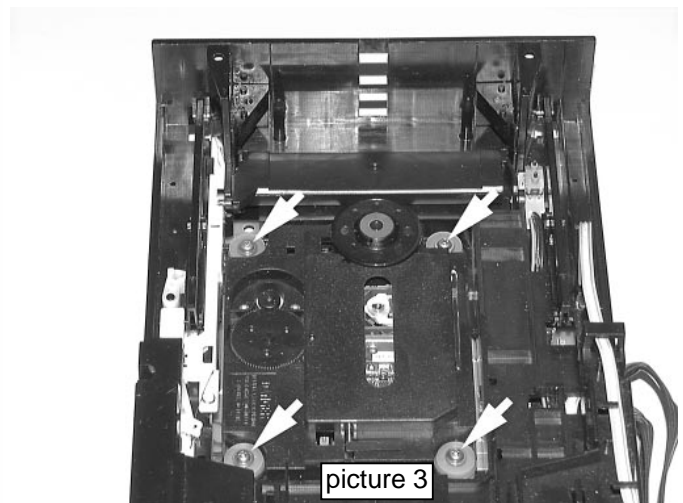
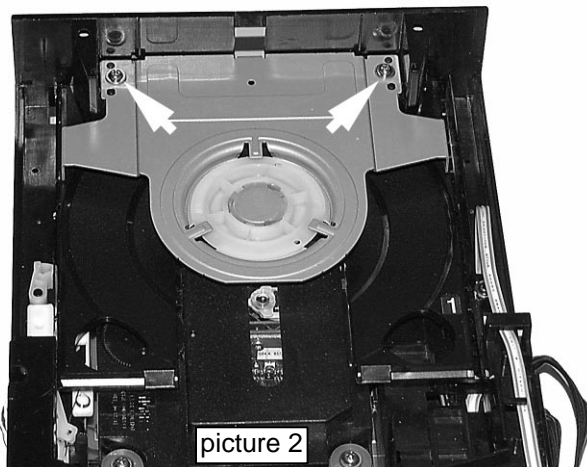
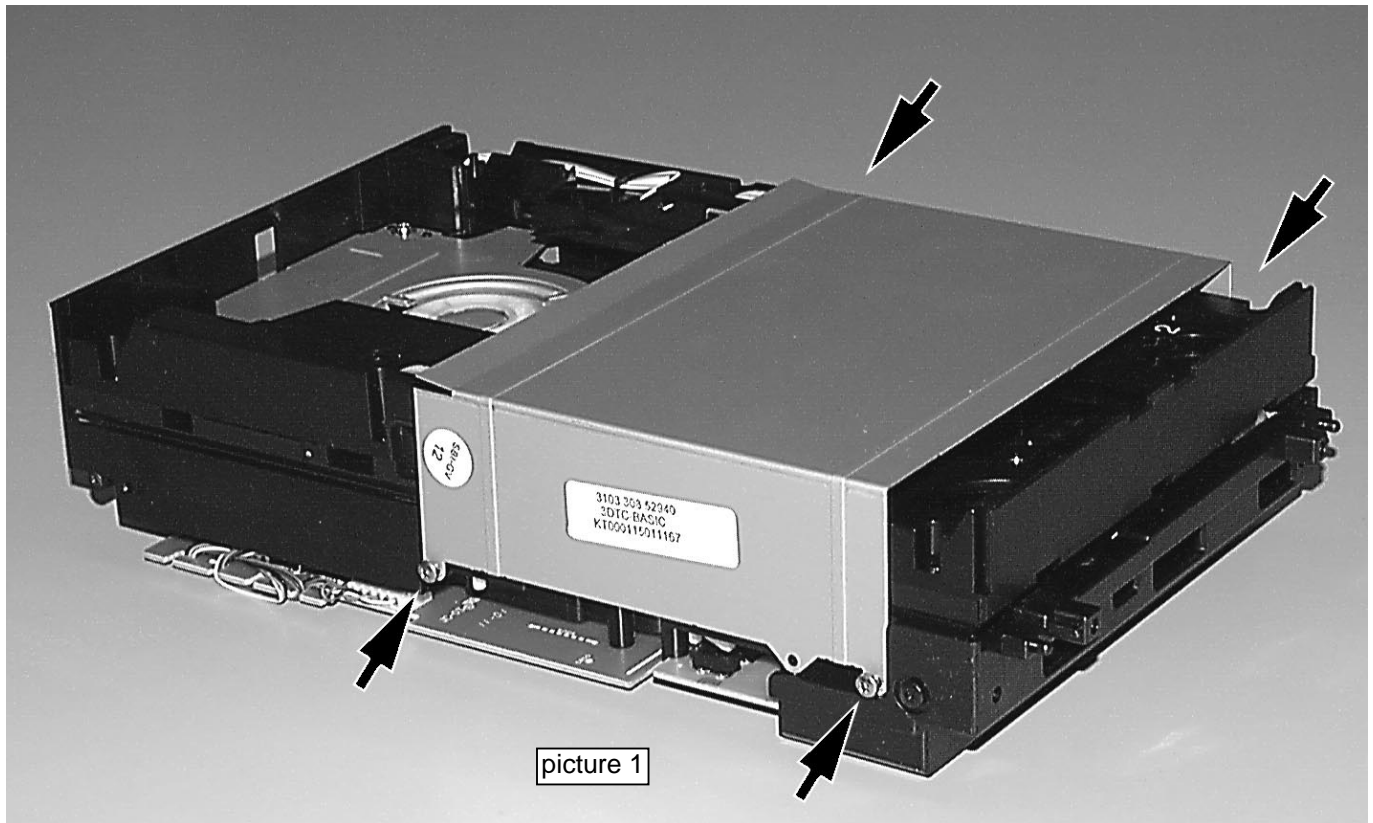

Jammed carriage, blocked tray

If the tray can't be opened via open close dismantle the top and side cover of the set and remove the metal cover of the loader unit as shown in picture 1.

If the carriage is in a position as shown in picture 4, the complete loader unit is locked.

In this state clammer **A** is in upper position and carriage **B** is jammed under the clammer.

Problem : The tray cannot open as long as the clammer is in upper position and the clammer cannot move down because of the jammed carriage.

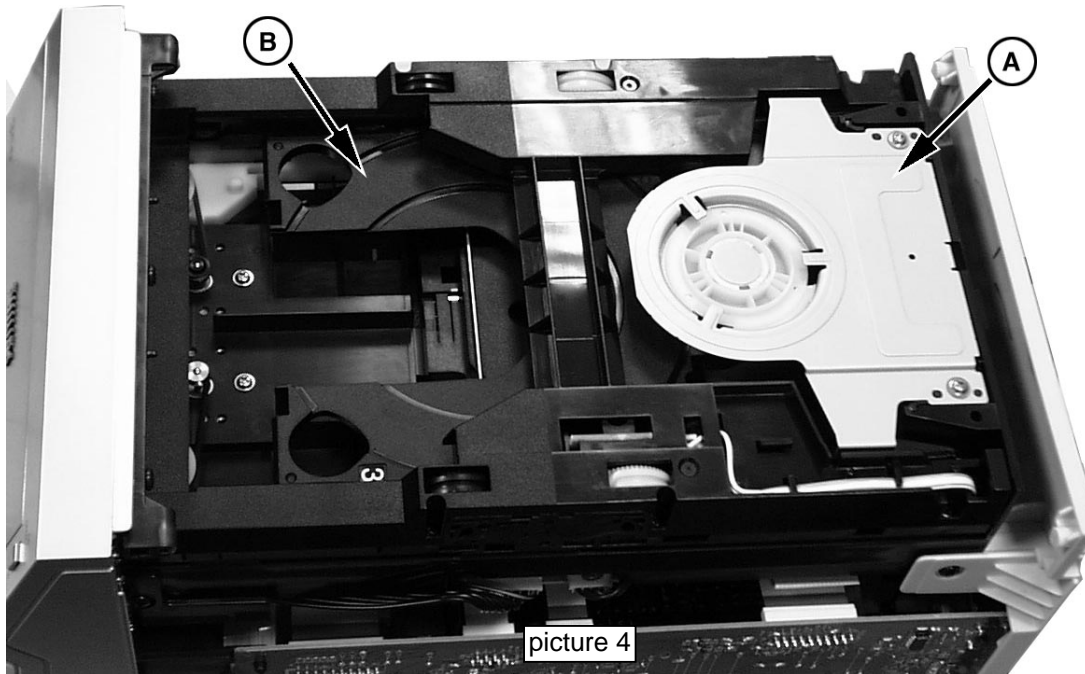

The problem can only be fixed as follows

1. Loosen 2x screw (see picture 5).
Remove bracket with clammer.
2. Shift lever (pin) to the left as shown in picture 6. This action releases the tray.

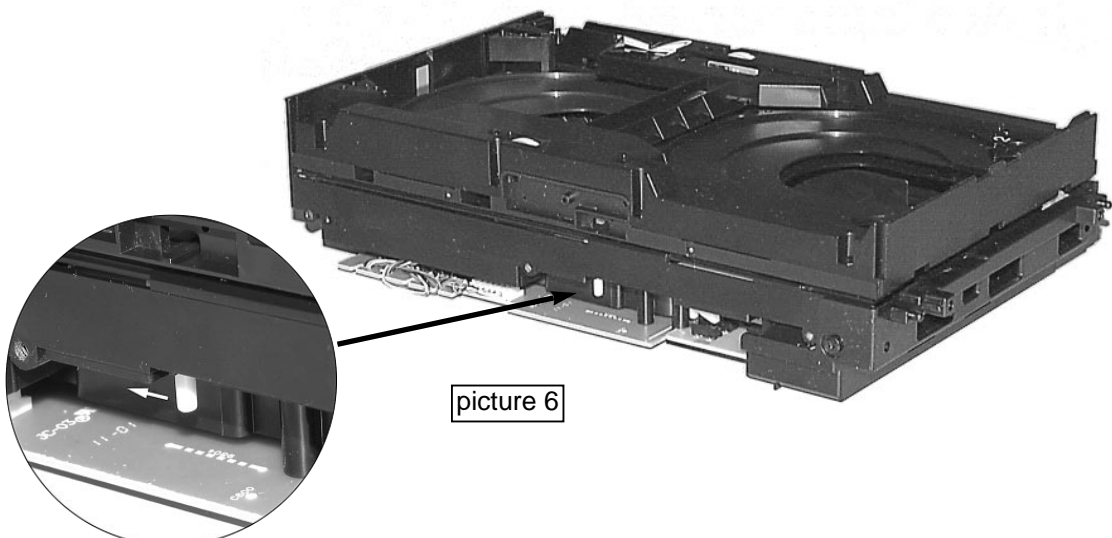
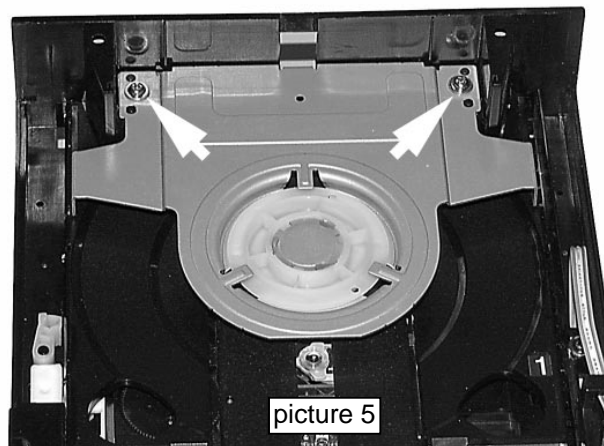

Jammed carriage, blocked tray (continued)

3. Shift lever (block) backwards as shown in picture 7 → Tray moves approx. 1cm outside.
4. Pull out the tray manually.
5. Remove carriage above the CD-drive.
WARNING: Don't apply mechanical force to the tray. Bend carriage - as shown in picture 8 - to release guidings.

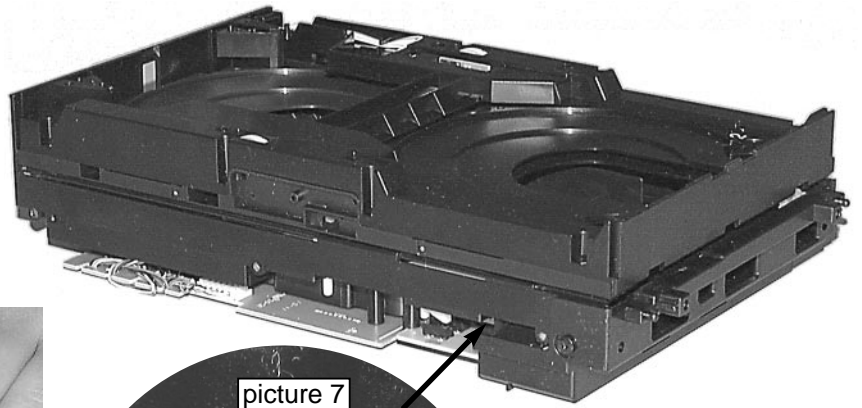

picture 7

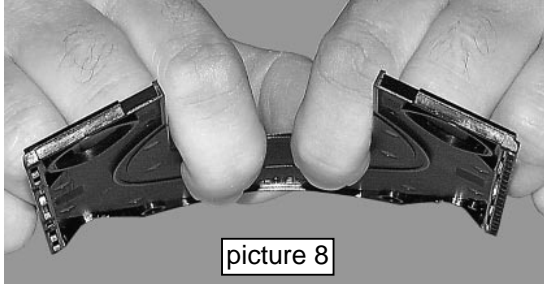

picture 8

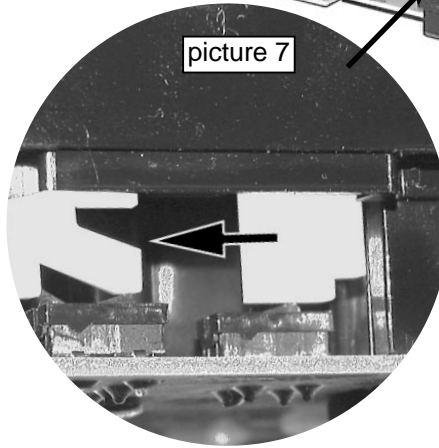

6. Turn pulley as shown in picture 9 to move next carriage over CD-drive.
7. If necessary repeat step 5 and 6 until all carriages are removed.

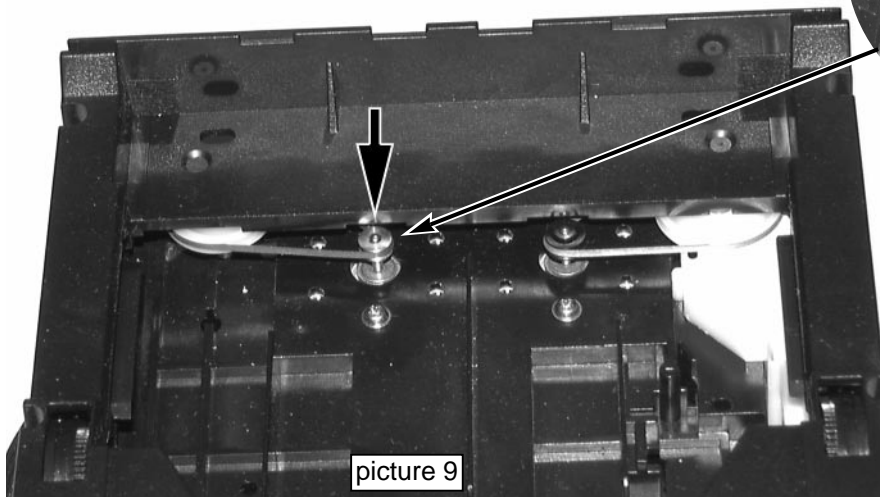
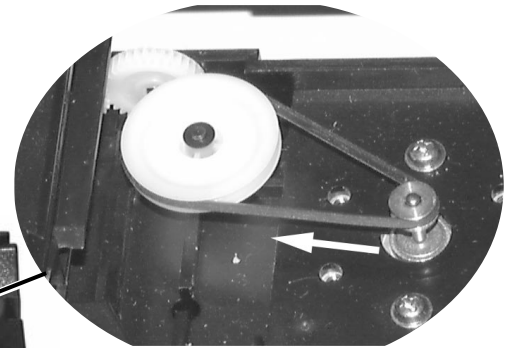

picture 9

Reassembling the tray

1. Insert carriage #1 above CD-drive.
Attention: The 3 carriages are different (see picture 10).
2. Mount clamper (2x screw - see picture 5).
3. Connect mains. Set initializes → Clamper moves down.
4. Select CD 2 → Clamper moves up → Carriage #2 (not yet inserted) will be moved above CD-drive → Carriage #1 moves back → Clamper moves down.
5. While clamper moves down disconnect mains.
6. Open tray - using lever (block) as shown in picture 7.
 Lift clamper - using lever (pin) as shown in picture 11.
7. Insert carriage #2 above CD-drive.
8. Lower clamper, close tray, connect mains.
 Set initializes → carriage #1 moves above CD-drive → Clamper moves down.
9. Select CD 3. → Clamper moves up → carriage #3 (not yet inserted) will be moved above CD-drive → carriage #1 moves back → Clamper moves down.
10. While clamper moves down disconnect mains.
11. Open tray - using lever (block) as shown in picture 7.
 Lift clamper - using lever (pin) as shown in picture 11.
12. Insert carriage #3 above CD-drive.
13. Lower clamper, close tray, connect mains.
 Set initializes → Carriage #1 moves above CD-drive → Loader unit reassembled successfully.

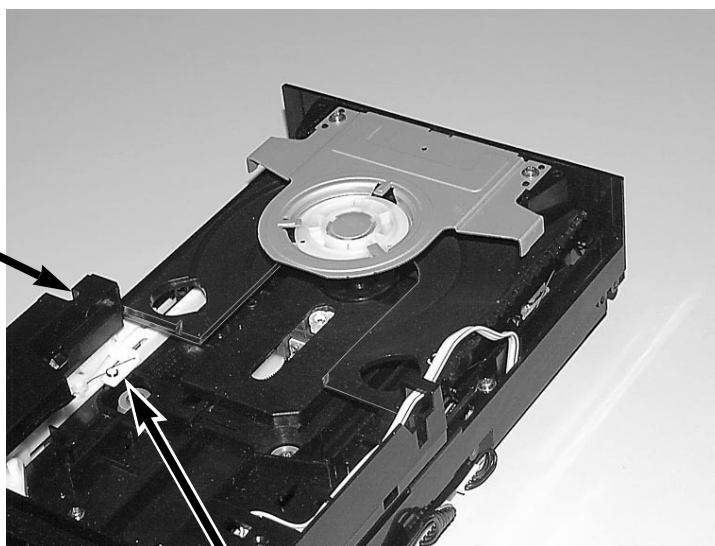
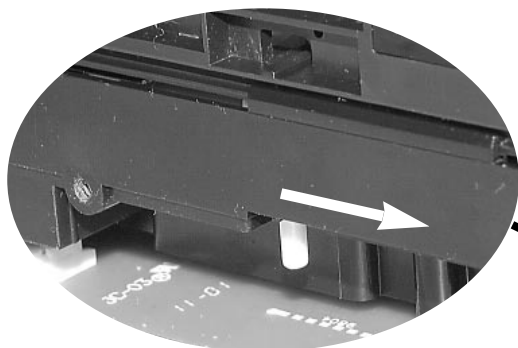
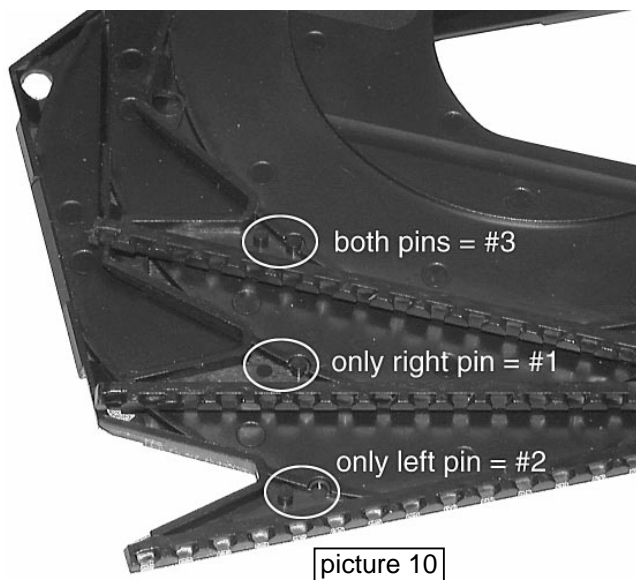

picture 11

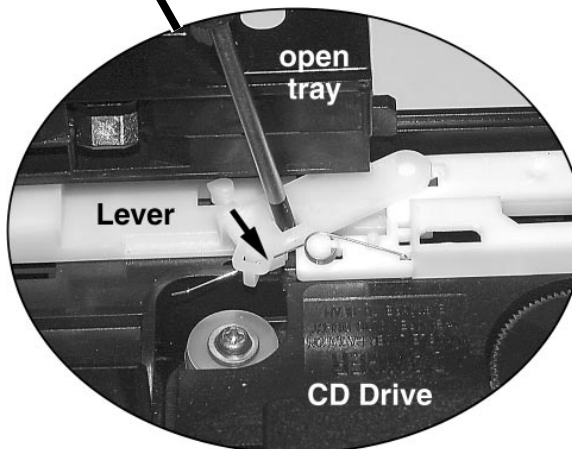

Move lever to
unlock clamper

Replacing the Gears (pos. 3 & 4)

1. Disassemble complete Loader unit.
 2. Shift lever (block) backwards as shown in picture 7 → Tray moves approx. 1cm outside. Pull out the tray manually.
 3. Demount right side of tray (see picture 12).
 4. Close tray (simply push inside).
 5. Demount left side of tray (see picture 13).
Lift right side as high as possible.
- Attention:** The two gearwheels shown in detail **A** resp. detail **B** come loose easily!

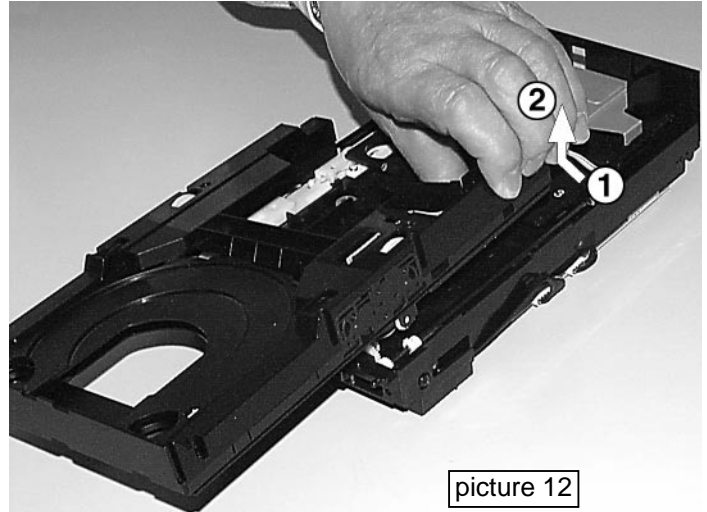

picture 12

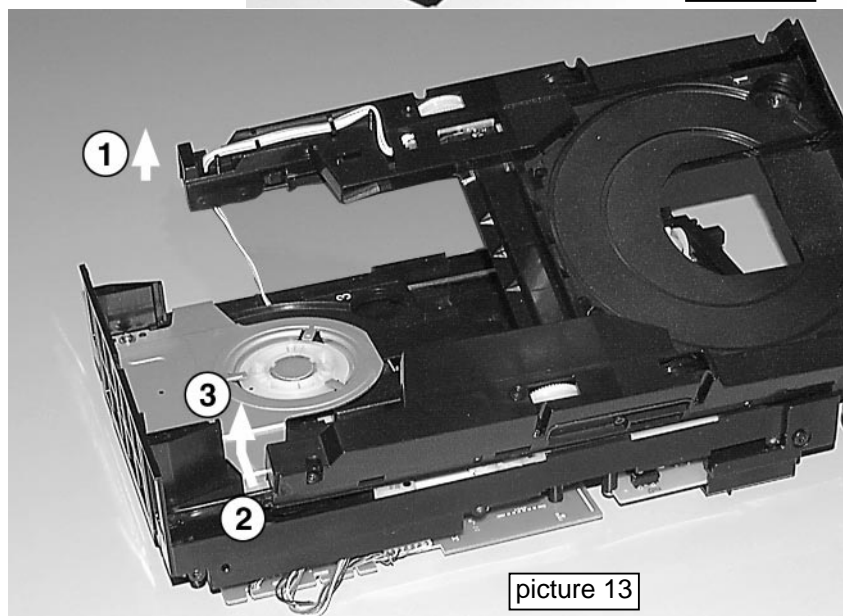

picture 13

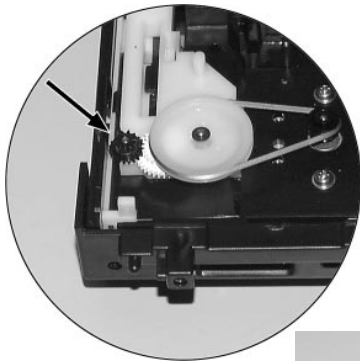

Detail A

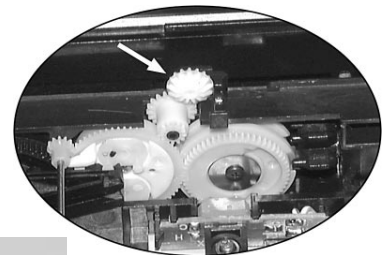

Detail B

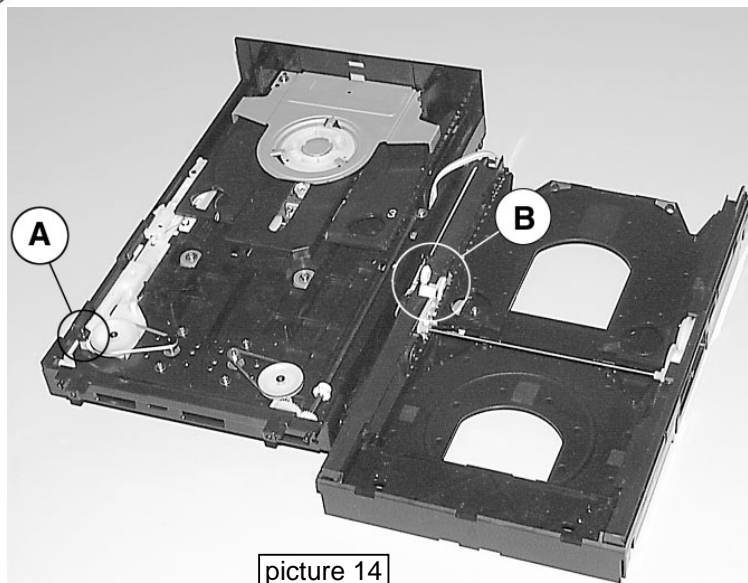

picture 14

Replacing the Gears (continued)

6. Turn gearwheel **A** as shown in picture 15 → carriage moves right.
7. Lift carriage as shown in picture 16 and remove it.
8. Turn gearwheel **A** in the other direction → remaining carriage moves right.
9. Lift carriage as shown in picture 16 and remove it.
10. Turn round tray and align gear as shown in picture 17, detail **C**.
11. Fix the gear with a pin (e.g. a paperclip d=1mm) see detail **B**.
12. Loosen 4x screw as shown in picture 17, detail **D**.

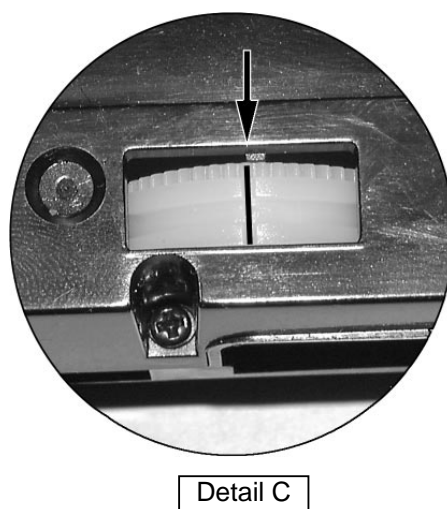
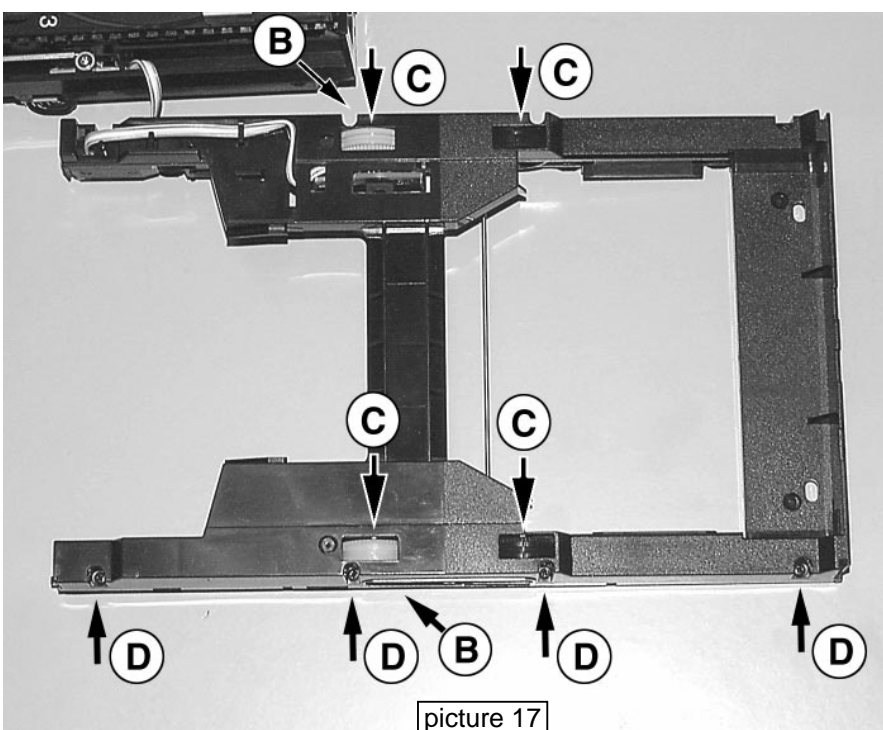
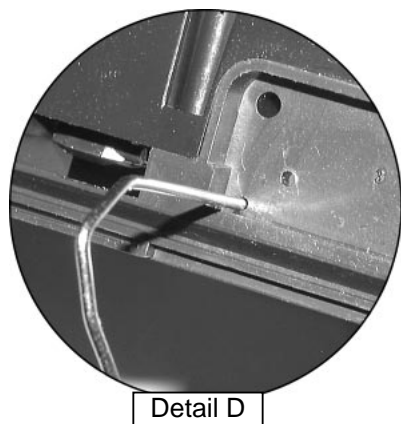
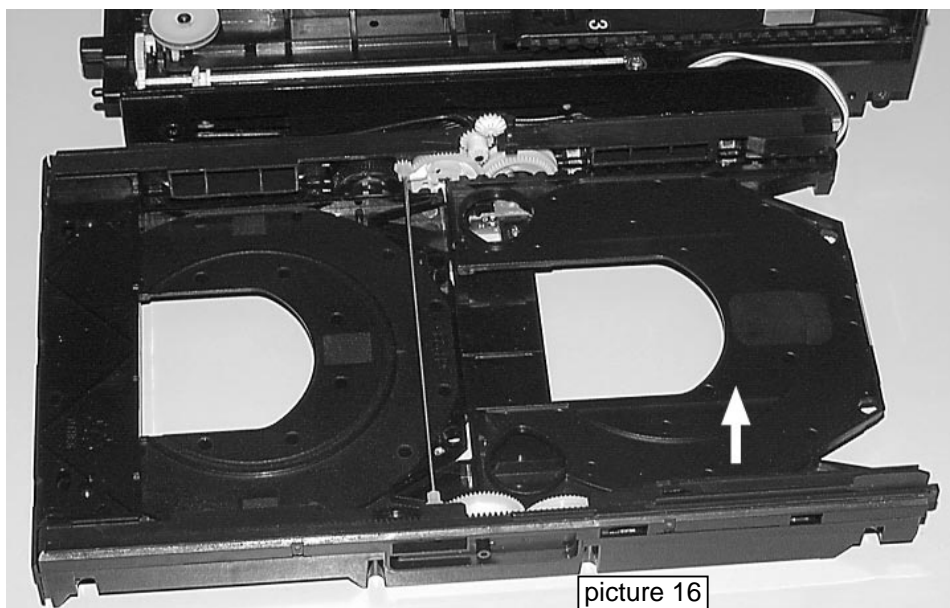
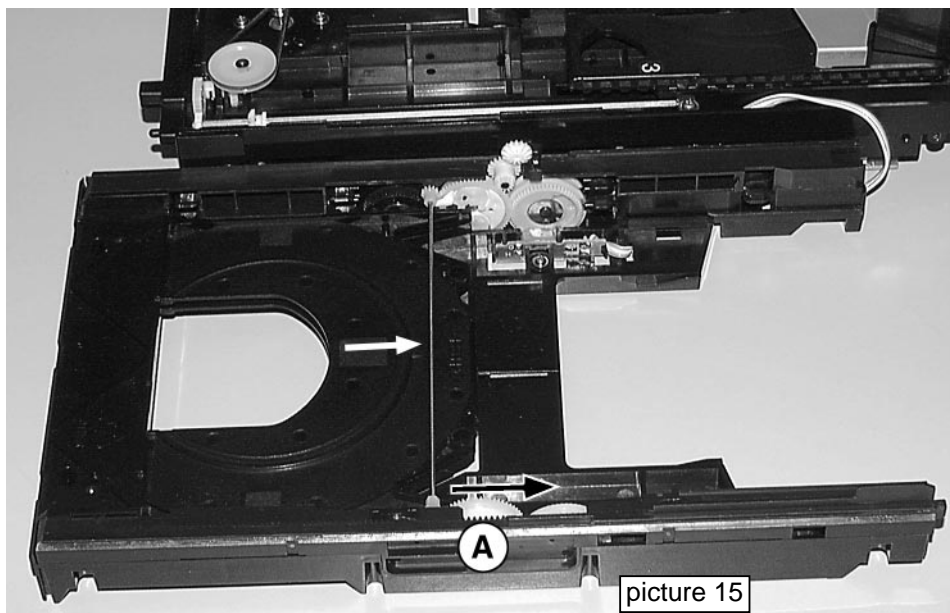

Replacing the Gears (continued)

13. Replace gear pos.3 and/or 4. Make sure that the new gear is aligned as shown in picture 17, detail © as well. To avoid damage of the switches when inserting the gear, use a strip of paper as shown in picture 18.
14. Fix gear with 4x screw (see picture 17, ©).
15. Check if gear is aligned as shown in picture 17 detail ©.

Inserting the Carriages

16. Turning gear (A) as shown in picture 19 will move the upper and lower wheel of gear (B) alternately.
Turn gear (A) until the lower wheel stops moving and upper one starts moving.
17. Insert right side of carriage #3 (= side with the toothrack) as shown in picture 20.

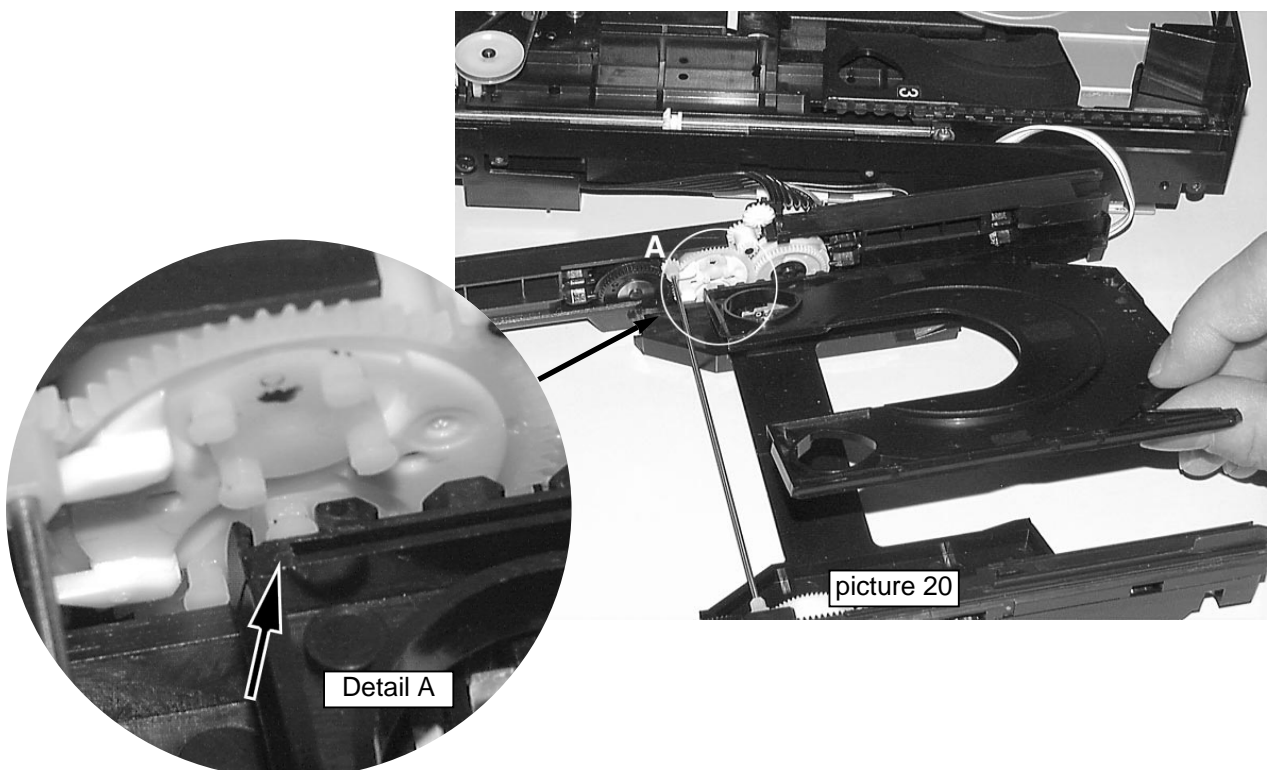
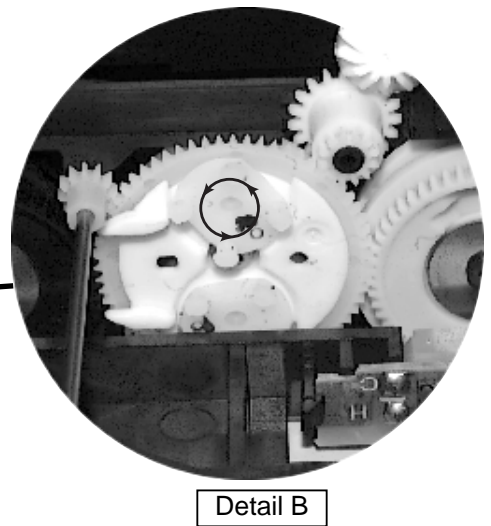
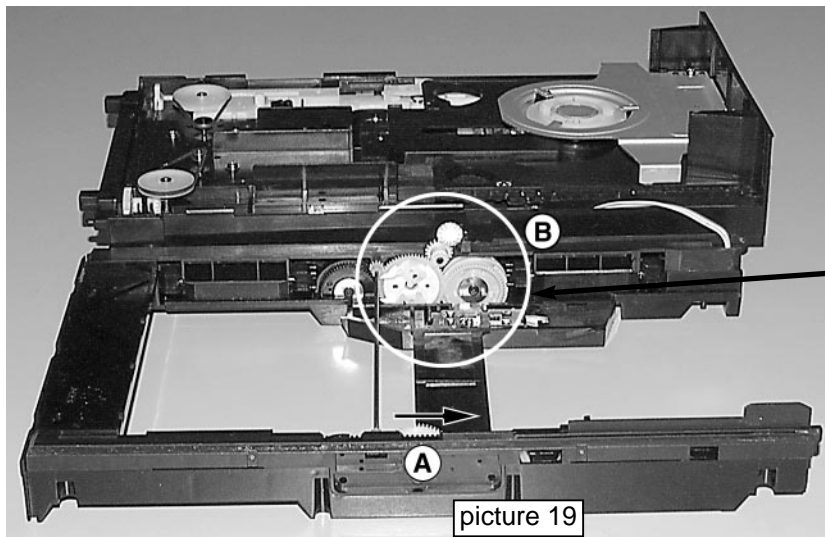
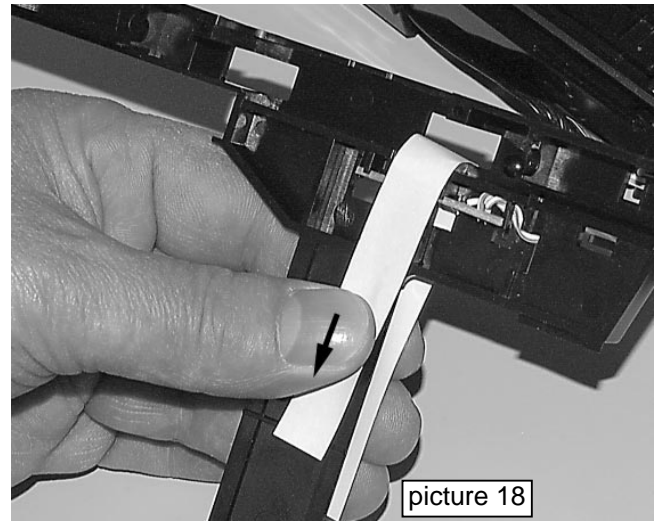

Inserting the Carriages (continued)

18. Insert other side of carriage as shown in picture 21.
19. Turning gear **A** as shown in picture 19 will move carriage inside. After reaching the endposition the upper wheel (picture 19 **B**) starts turning.
20. Insert carriage #2 as shown in picture 20 and 21.
21. Lift carriage #3 while turning gear **A** (see picture 22).
22. Lift clamber and insert carriage #1 above CD-drive.
23. Shift lever as shown in picture 23.

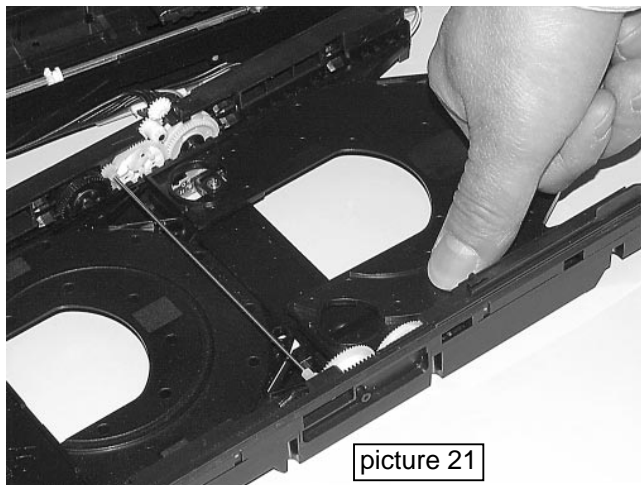

Assembling the Tray

24. Lift back side of tray as high as possible.
Assemble tray starting at position 1 as shown in picture 24.

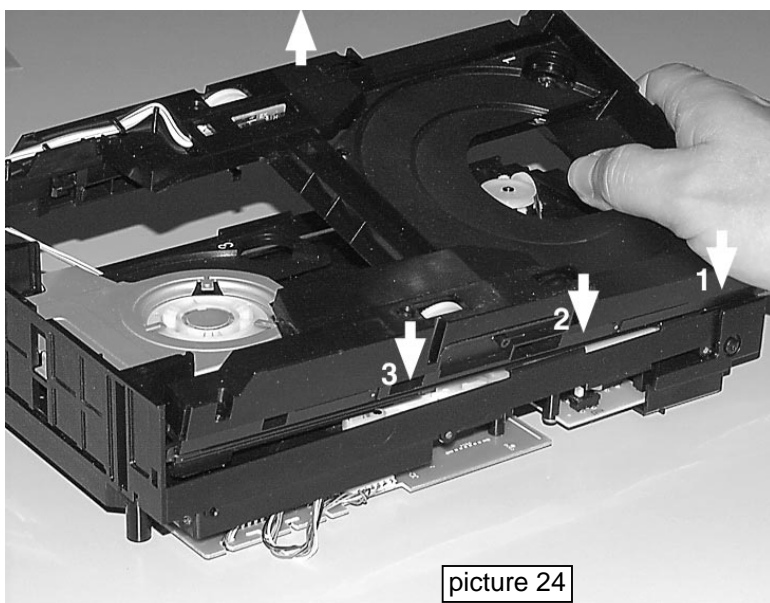
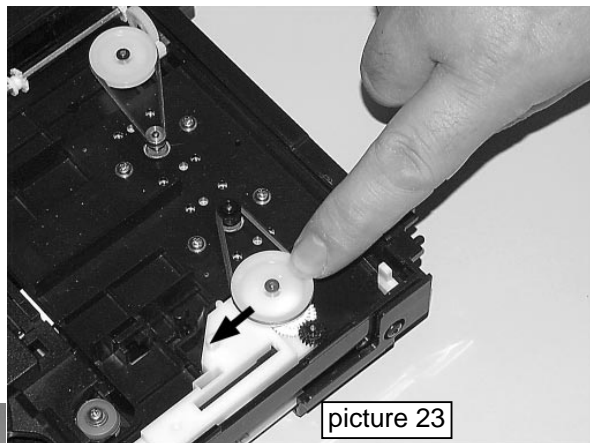
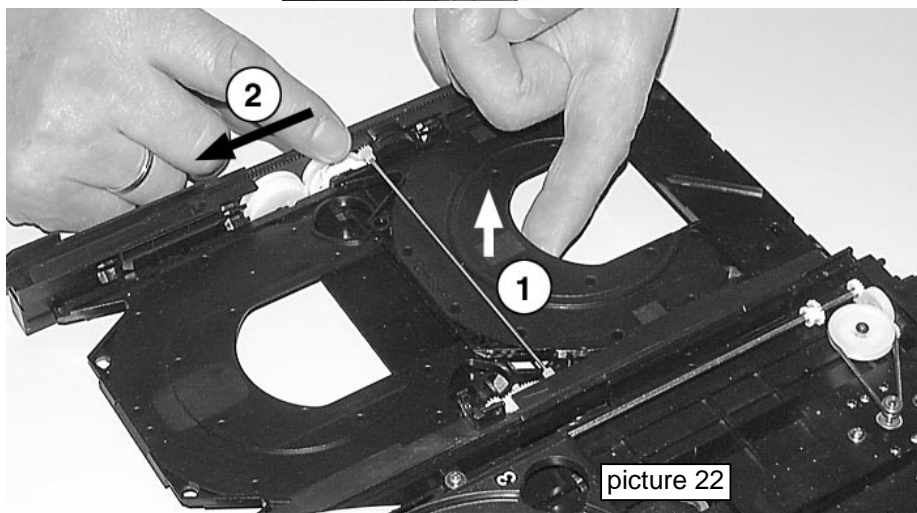

Assembling the Tray (continued)

25. Move tray outside (simply pull the tray).
26. Align toothed wheel **A** as shown in picture 25.
27. Snap in other side of tray as shown in picture 26.
28. Move tray inside (simply push).
29. Done.

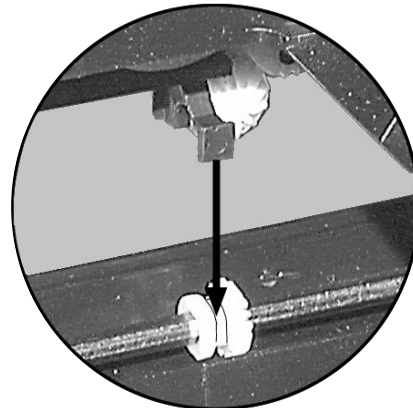
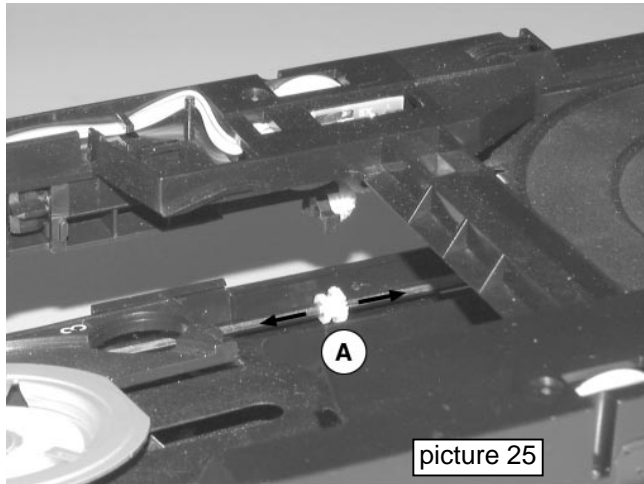

Detail

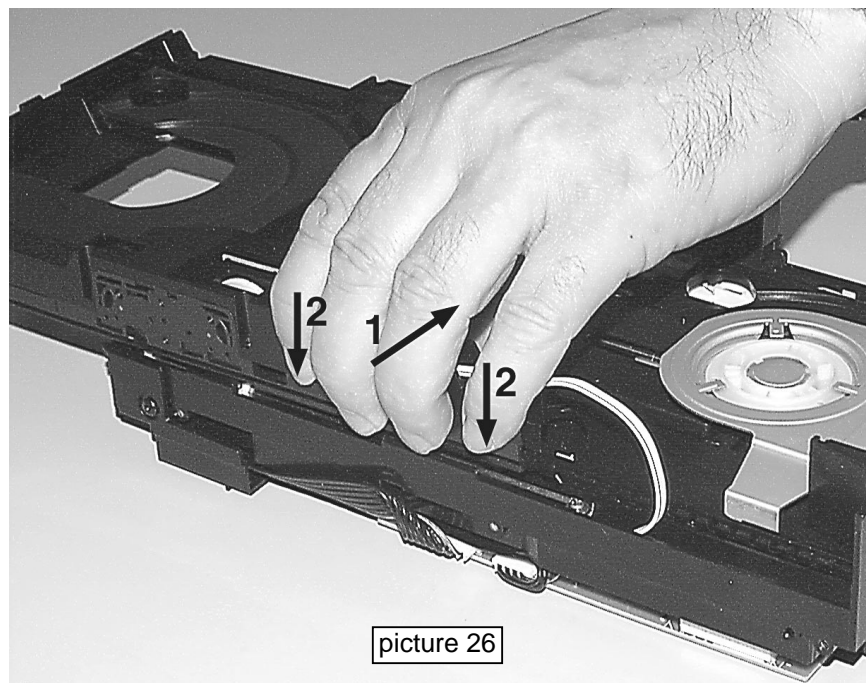

picture 26

**3Disc Tray Changer
Exploded view**

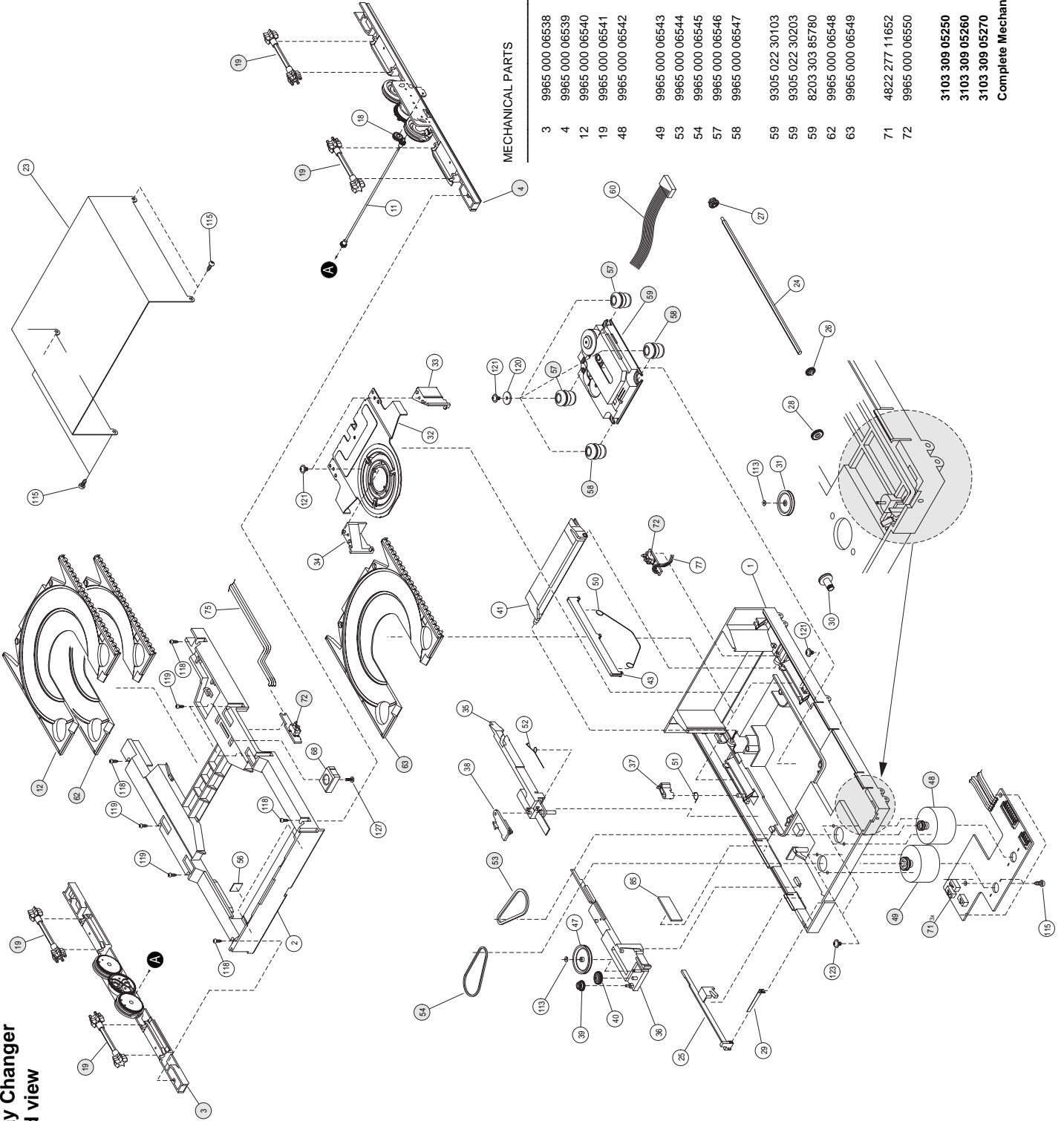

MECHANICAL PARTS

3	9965 000 06538	ASSY HOLDER LEFT
4	9965 000 06539	ASSY HOLDER RIGHT
12	9965 000 06540	ASSY CARRIAGE 1 (TOP)
19	9965 000 06541	ASSY GEAR STAR
48	9965 000 06542	ASSY MOTOR CARRIAGE
49	9965 000 06543	ASSY MOTOR DRAWER
53	9965 000 06544	BELT DRAWER
54	9965 000 06545	BELT CARRIAGE
57	9965 000 06546	DAMPER RUBBER REAR
58	9965 000 06547	DAMPER RUBBER FRONT
59	9305 022 30103	CD DRIVE VAM2201/03 (1x SPEED)
59	9305 022 30203	CD DRIVE VAM2202/03 (2x SPEED)
59	8203 303 85780	CD DRIVE VAM2204/03 (4x SPEED)
62	9965 000 06548	ASSY CARRIAGE 2 (MIDDLE)
63	9965 000 06549	ASSY CARRIAGE 3 (BOTTOM)
71	4822 277 11652	SWITCH (SW6-SW6)
72	9965 000 06550	SWITCH (SW2-SW5)
3103 309 05250		3DTC MECH. CMCJ-01-13 (1xSPEED)
3103 309 05260		3DTC MECH. CMCJ-01-14(2xSPEED)
3103 309 05270		3DTC MECH. CMCJ-01-15(4xSPEED)

Complete Mechanic - CD Drive already included